

20ft Refurbished Combo Office and Storage Container

SKU: 20STCBRX

20' x 8'6"

Buy Online



Standard Features

- Heavy Duty Corrugated Steel Construction
- Ground-level entry (no ramps required)
- Weather-resistant, wind & cargo worthy
- Marine-grade plywood flooring
- Secure steel man door
- Barred windows for security
- Insulated interior walls & ceiling

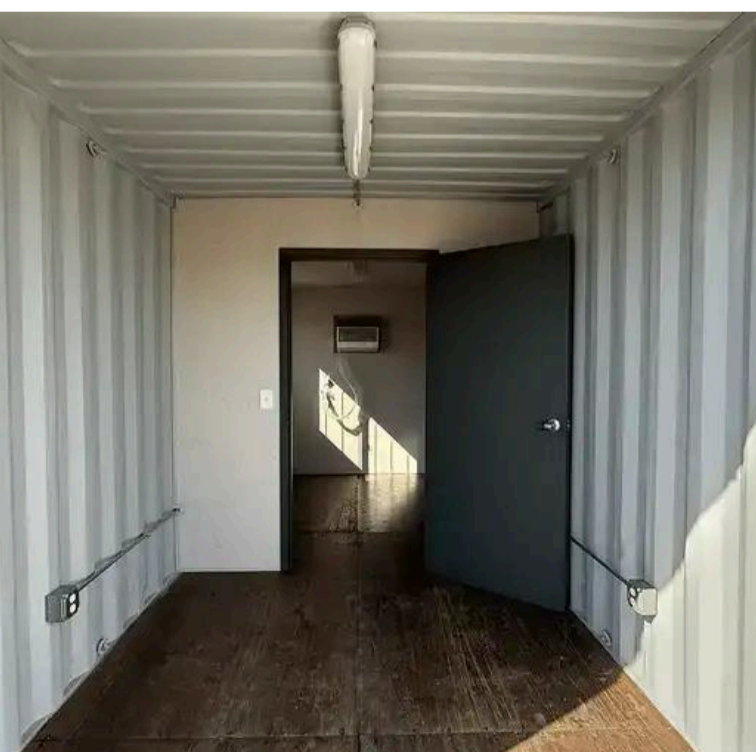

SHOP DRAWINGS

	20FT REFURBISHED COMBO OFFICE AND STORAGE CONTAINER		SKU: 20STCBRX	
--	---	--	---------------	--

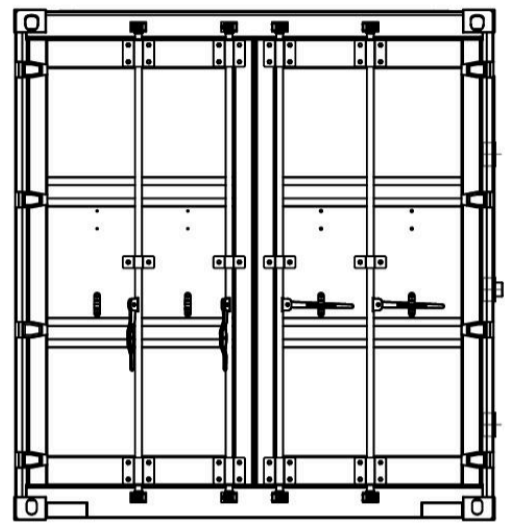
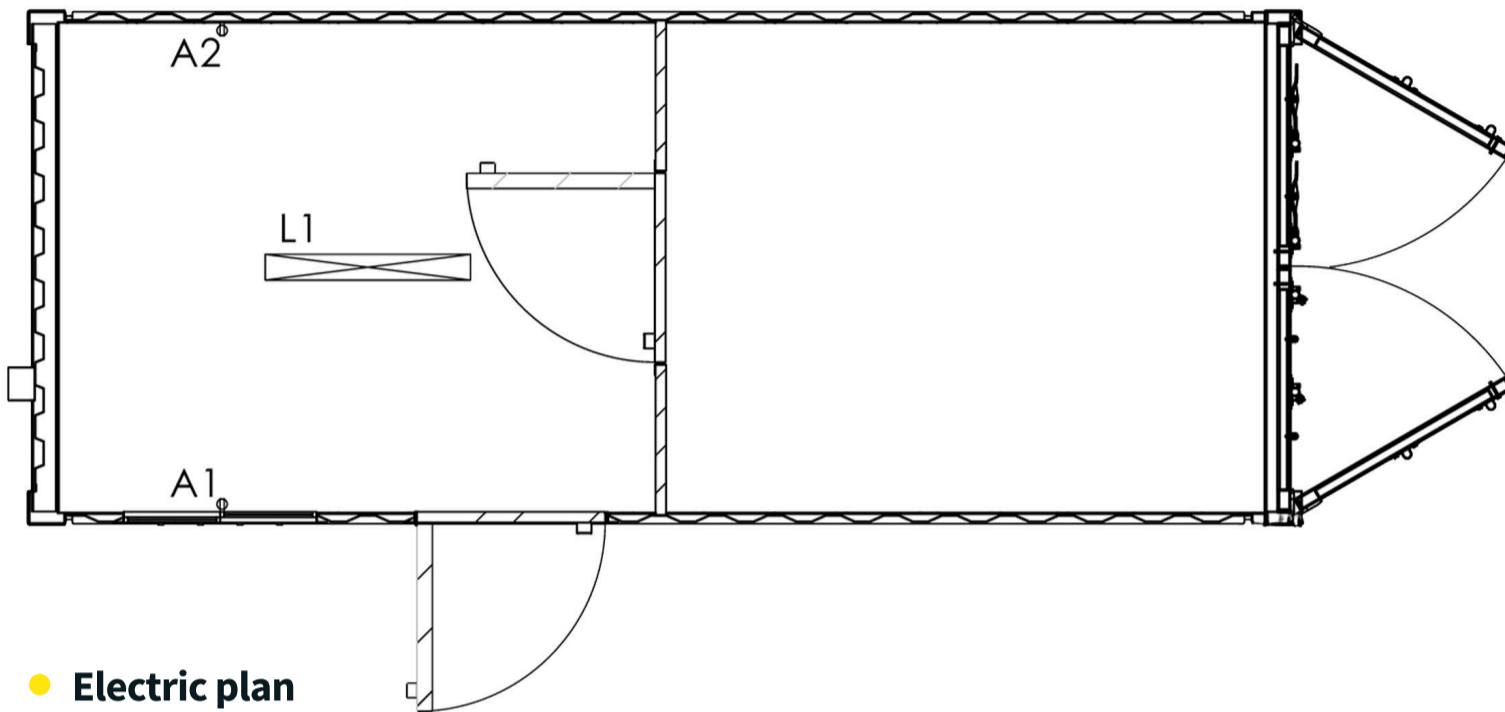

● **Electric plan**
L1 - Ceiling light fixture

A1 / A2 - Electrical outlets

● **Front side view**

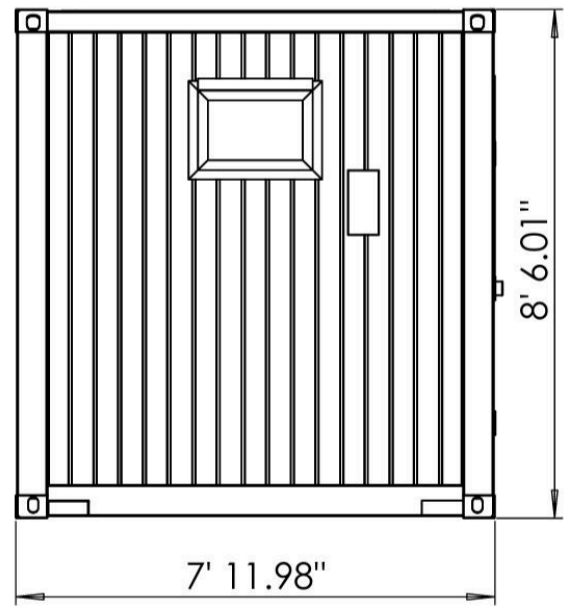
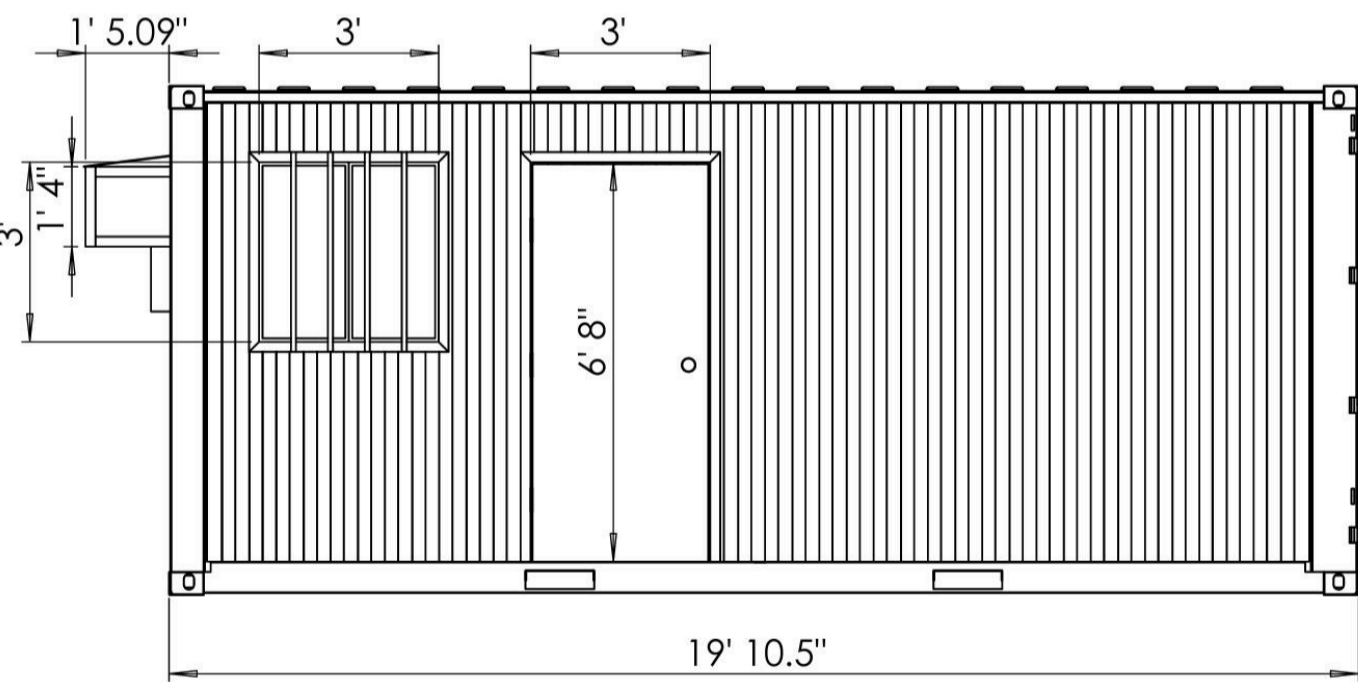

● **Right side view**

● **Rear side view**

--	--	--	--	--	--	--	--	--

Key Benefits

- ✓ Ready-to-use office space
- ✓ Ground-level access for easy entry
- ✓ Cost-effective refurbished option
- ✓ Ideal for temporary or permanent offices
- ✓ Secure & weather-resistant workspace

Common Uses

- Job site office
- Site supervision or management office
- Security or gate office
- Check-in or control room

Specifications

	Length	Width	Height	Weight
External Dimensions	20' (6.1m)	8' (2.44m)	8'6" (2.59m)	 4,800–5,500 lbs 2,175–2,495 kg
Internal Dimensions	19'4" (5.89m)	7'8" (2.34m)	7'10" (2.39m)	
Cargo Door Dimensions	-	7'8" (2.34m)	7'5" (2.28m)	

Custom Fabrications

- Custom Exterior Color
- Climate Control (HVAC)
- Dual Pane Windows
- Electrical Package
- Ventilation
- R13 Insulation

 TILT-BED TRUCK	65ft of straight clearance, 12ft width, and 14 ft vertical clearance. No equipment required	 Local delivery starting at \$350
 FLATBED TRUCK	65 ft of straight clearance, 12 ft width, 14 ft vertical clearance, and side access for unloading. Need a forklift rated for at least 10,000 lbs to remove the container	

Available Accessories

- Heavy Duty container Ramps
- Heavy Duty container Locks
- Light Duty Ramps
- Shelves
- ConexRamps
- Cargo container Lock
- More on conexwest.com ↗

Optional Fabrication

- Custom Exterior Color
- Window
- Electrical Package
- Cargo Door Lock Box
- Ventilation
- and more
- HVAC
- R13 Insulation