

CLASSIFICATION		CLASSIFICATION	
EXTERNAL	LENGTH	6058 ⁰ / ₋₆	20' ⁰ / _{-15/64"}
	WIDTH	2438 ⁰ / ₋₅	8' ⁰ / _{-3/16"}
	HEIGHT	2591 ⁰ / ₋₅	8'-6" ⁰ / _{-3/16"}
INTERNAL	LENGTH	5774 ⁰ / ₋₁₂	18'-11 21/64" ⁰ / _{-15/32"}
	WIDTH	1795 ⁰ / ₋₁₀	5'-10 43/64" ⁰ / _{-25/64"}
	HEIGHT	2298 ⁰ / ₋₁₀	7'-6 15/32" ⁰ / _{-25/64"}
DOOR	WIDTH	1737 ⁰ / ₋₅	5'-8 25/64" ⁰ / _{-3/16"}
OPENING	HEIGHT	2232 ⁰ / ₋₅	7'-3 7/8" ⁰ / _{-3/16"}
	CARGO ACCESS HEIGHT	2232 ⁰ / ₋₅	7'-3 7/8" ⁰ / _{-3/16"}
INTERNAL CUBIC CAPACITY		23.8 CU.M	841 CU.FT

MAX GROSS WEIGHT (INDICATED)	24,000 KGS	52,910 LBS
TARE WEIGHT (±2%)	EXCLUDING UNIT	2,710 KGS
	INCLUDING UNIT (UNIT: 370KG*2=740KG)	3,450 KGS
MAX PAYLOAD	20,550 KGS	45,310 LBS

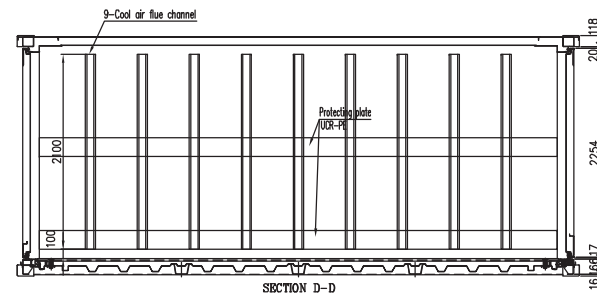
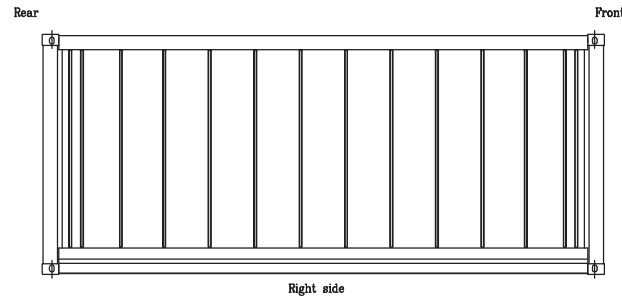
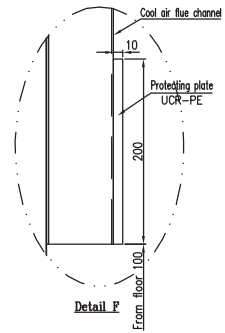
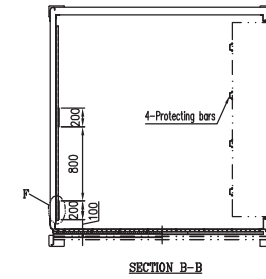
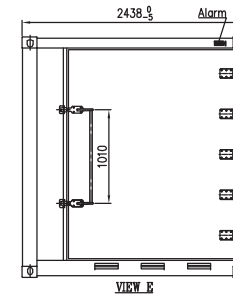
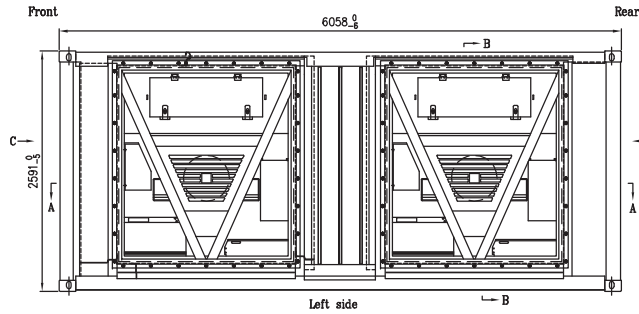
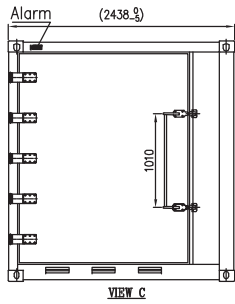
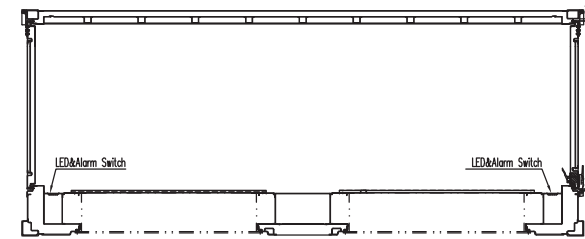
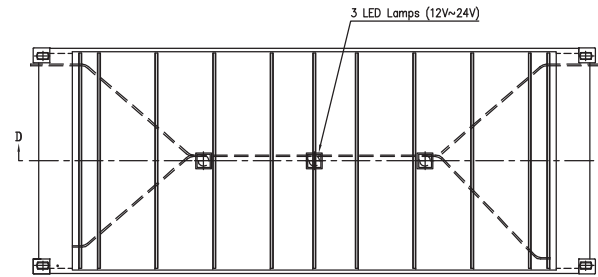

TITLE: 20'x8'x8'6" REEFER GENERAL ARRANGEMENT					
OWNED	CIMC	SCALE	1 : 45	QTY.	1
DESIGNED	TJH	DATE	2019.09.29	DWG. NO.:	S20-05GD-000A
CHECKED		DATE		SHEET	1 OF 1 SHEETS
APPROVED		DATE			

ISSUE DATA DESIGNED CHECKED APPROVED